



Friedhelm TRAPP GmbH

Ostring 15 - 63533 Mainhausen - Zentrale: 06182/9294-5 - Fax: 06182/9294-69 - Mail: trapp@f-trapp.de

www.f-trapp.de

Waste bin TAB-3002.20/30

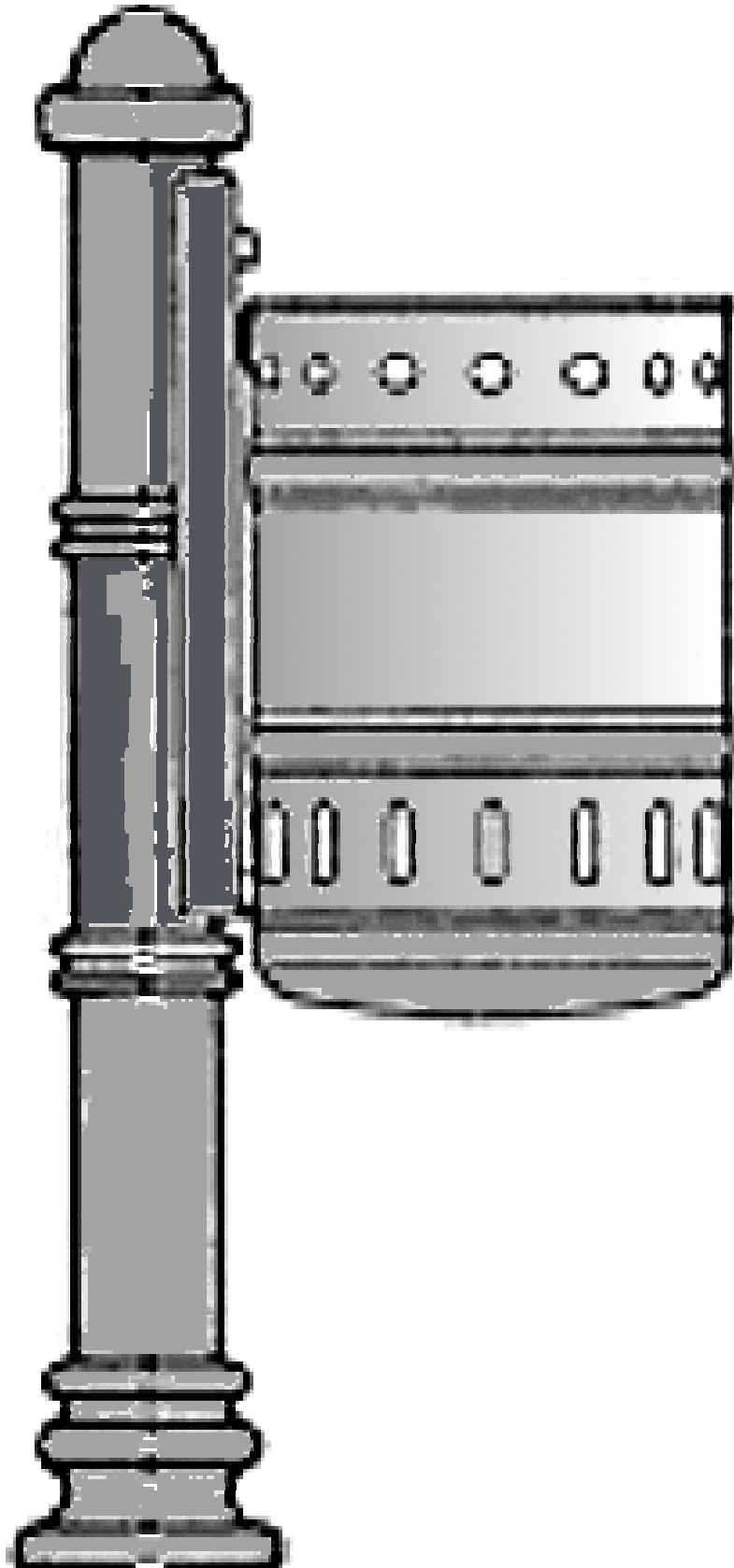



Friedhelm TRAPP GmbH

Ostring 15 - 63533 Mainhausen - Zentrale: 06182/9294-5 - Fax: 06182/9294-69 - Mail: trapp@f-trapp.de

www.f-trapp.de

Waste bin TAB-3002.20/30

Technical description:

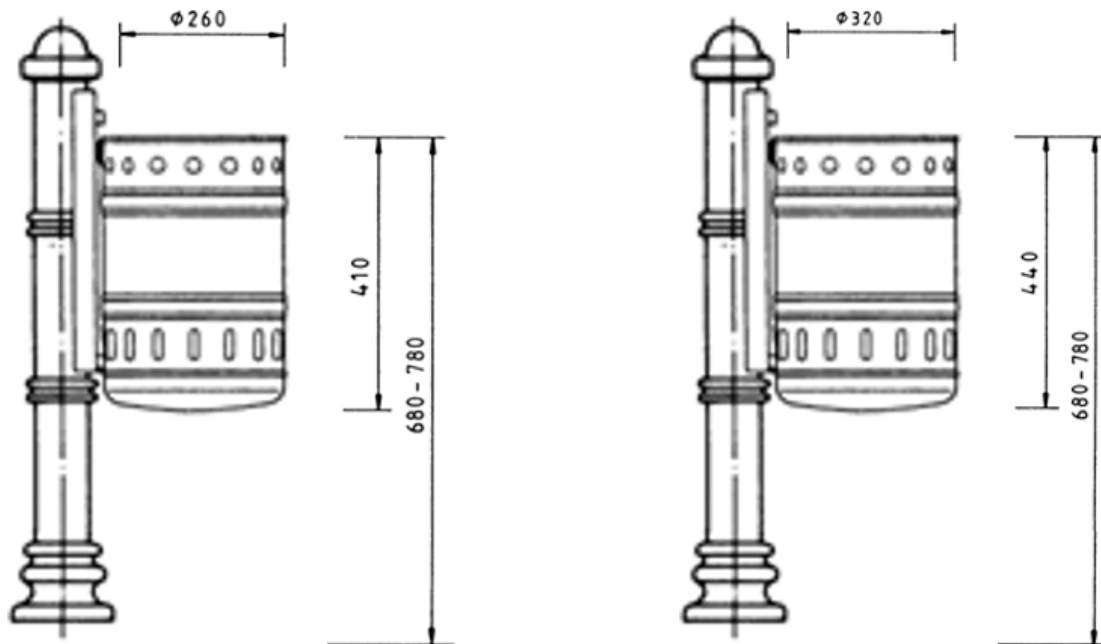

Waste bin TAB-3002.20

Waste bin TAB-3002.30

Can be combined with various bollards of our program

Material:

Container: Galvanized sheet steel, removable

Locking splint: folded sheet steel, hot dip galvanized

Coating:

2 or 3 times lacquered, top coat RAL color of your choice

Connecting elements:

made of stainless steel

Container capacity:

TAB-3002.20: approx. 21 liters with triangular locking mechanism

TAB-3002.30: approx. 33 liters with triangular locking mechanism